

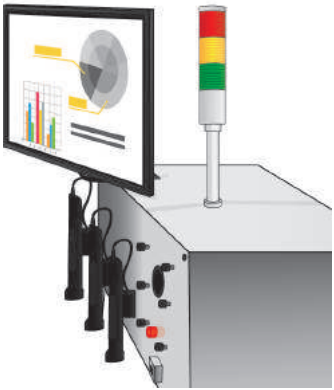





타워램프 취부대

타워램프의 취부방법

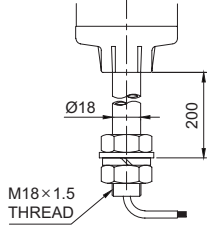
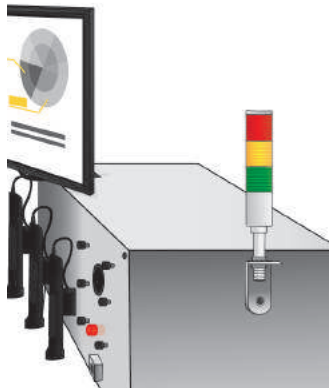

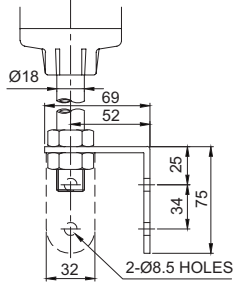
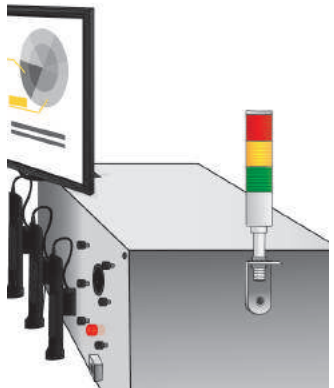

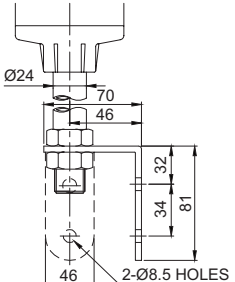
당사의 타워램프는 설치환경이나 조건에 따라 다양한 취부대를 사용할 수 있습니다.

(단위 : mm)

특징	외형	치수 및 적용 제품
<p>Pole이 취부된 표준형 제품입니다. Pole의 끝단에 나사가 가공되어 있고 취부에 필요한 너트가 체결되어 있습니다.</p> <p>재질 : Steel</p> 	 <p>18mm SCREW & NUT (표준)</p>	 <p>ST45B, ST45BF, ST45L, ST45LF, ST56B, ST56BF, ST56L, ST56LF, ST56EL, ST56ELF, STC45L, STC56EL, STC56L, QT50L, QT50LF, QT50LS, QT50LR, STG40L, STG40LF, STG50L, STG50LF, ST45L-ETN, ST56EL-ETN, ST56L-ETN, ST45L-USB, ST56EL-USB, ST56L-USB</p>
<p>표준 Pole 취부 제품에 'L형' 취부대가 장착된 제품입니다. 벽면과 같은 수직면에 제품을 취부할때 사용됩니다.</p> <p>재질 : Steel</p> 	 <p>LB18</p>	 <p>ST45B, ST45BF, ST45L, ST45LF, ST56B, ST56BF, ST56L, ST56LF, ST56EL, ST56ELF, ST56WL, STC45L, STC56EL, STC56L, QT50L, QT50LF, QT50LS, QT50LR, STG40L, STG40LF, STG50L, STG50LF, ST45L-ETN, ST56EL-ETN, ST56L-ETN, ST45L-USB, ST56EL-USB, ST56L-USB</p>
	 <p>LB24</p>	 <p>ST80B, ST80BF, ST80L, ST80LF, ST80EL, ST80ELF, STC80L, STC80LF, STC80EL, STC80ELF, QT70L, QT70LF, QT70LS, QT70LR, ST80EL-ETN, ST80L-ETN, ST80EL-USB, ST80L-USB</p>



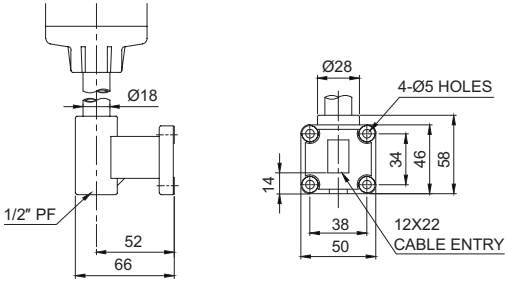

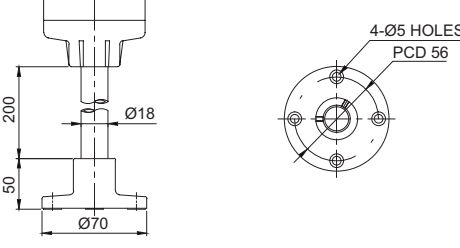

타워램프 취부대

(단위 : mm)

특징	외형	치수 및 적용 제품
<p>고급형 수직 취부대입니다. 벽면과 같은 수직면에 제품을 취부할 때 사용되며, 전선은 벽면 또는 Pole의 하부로 인출할 수 있습니다. 특히 Pole의 하부에 케이블 커넥터를 체결할 수 있는 나사가 가공되어 후렉시블 전선관 등을 사용할 수 있습니다.</p> <p>재질 : PC 색상 : Ivory</p> 	<p>외형 이미지</p> <p>LW18</p>	 <p>ST45B, ST45BF, ST45L, ST45LF, ST56B, ST56BF, ST56L, ST56LF, ST56EL, ST56ELF, STC45L, STC56EL, STC56L, QT50L, QT50LF, QT50LS, QT50LR, STG40L, STG40LF, STG50L, STG50LF</p>
<p>제품을 수평면에 취부할 때 사용하는 원형 취부대입니다.</p> <p>재질 : AI 색상 : Silver</p> 	<p>외형 이미지</p> <p>SZ18</p>	 <p>ST45B, ST45BF, ST45L, ST45LF, ST56B, ST56BF, ST56L, ST56LF, ST56EL, ST56ELF, STC45, STC56EL, STC56L, QT50L, QT50LF, QT50LS, QT50LR, STG50L, STG40LF, STG50L, STG50LF</p>
<p>제품을 수평면에 취부할 때 사용하는 원형 취부대입니다.</p> <p>재질 : AI 색상 : Silver</p> 	<p>외형 이미지</p> <p>SZ24</p>	 <p>ST80B, ST80BF, ST80L, ST80LF, ST80EL, ST80ELF, STC80L, STC80LF, STC80EL, STC80ELF, QT70L, QT70LF, QT70LS, QT70LR</p>

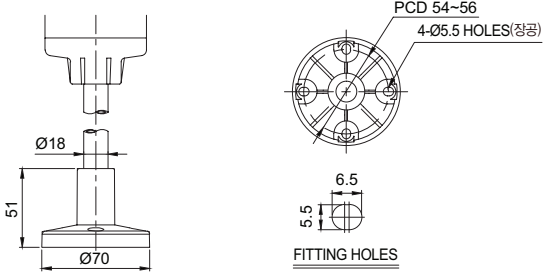

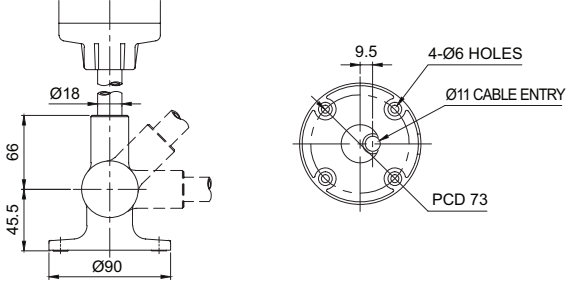

타워램프 취부대

(단위 : mm)

특징	외형	치수 및 적용 제품
<p>제품을 수평면에 취부할 때 사용하는 원형 취부대입니다.</p> <p>재질 : PC 색상 : Black</p> 	 <p>QZ18</p>	 <p>ST45B, ST45BF, ST45L, ST45LF, ST56B, ST56BF, ST56L, ST56LF, ST56EL, ST56ELF, STC45L, STC56EL, STC56L, QT50L, QT50LF, QT50LS, QT50LR, STG40L, STG40LF, STG50L, STG50LF</p>
<p>0도~180도(15도 간격 설정 가능) 조절이 가능하여 수평면, 수직면, 경사면 등 어떠한 취부 조건에서도 편리하게 취부할 수 있습니다.</p> <p>재질 : AI 색상 : Silver</p>	 <p>SL18</p>	 <p>ST45B, ST45BF, ST45L, ST45LF, ST56B, ST56BF, ST56L, ST56LF, ST56EL, ST56ELF, STC45L, STC56EL, STC56L, QT50L, QT50LF, QT50LS, QT50LR, STG40L, STG40LF, STG50L, STG50LF</p>
	 <p>SL24</p>	 <p>ST80B, ST80BF, ST80L, ST80LF, ST80EL, ST80ELF, STC80L, STC80LF, STC80EL, STC80ELF, QT70L, QT70LF, QT70LS, QT70LR</p>

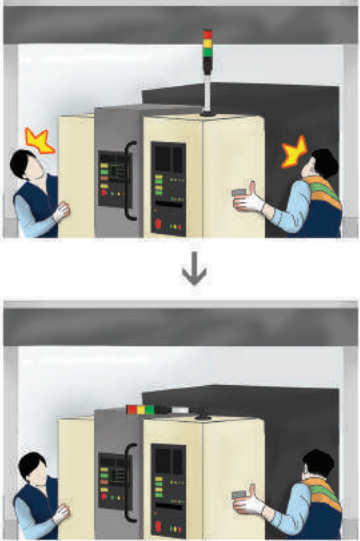
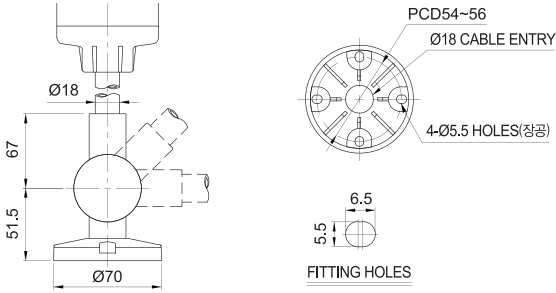





타워램프 취부대

(단위 : mm)

특징	외형	치수 및 적용 제품
<p>0도~180도(5도 간격 설정 가능) 조절이 가능하여 수평면, 수직면, 경사면 등 어떠한 취부 조건에서도 편리하게 취부할 수 있습니다.</p> <p>재질 : PC 색상 : Black</p> 	 <p>QL18</p>	 <p>ST45B, ST45BF, ST45L, ST45LF, ST56B, ST56BF, ST56L, ST56LF, ST56EL, ST56ELF, STC45, STC56EL, STC56L, QT50L, QT50LF, QT50LS, QT50LR, STG40L, STG40LF, STG50L, STG50LF</p>
<p>QLA 취부대는 각도 조절 버튼을 사용하여 별도의 공구없이 0도, 45도, 90도 각도로 조절 가능합니다.</p> <p>재질 : PC 색상 : Black</p> 	 <p>QLA18</p>	 <p>ST45B, ST45BF, ST45L, ST45LF, ST56B, ST56BF, ST56L, ST56LF, ST56EL, ST56ELF, STC45, STC56EL, STC56L, QT50L, QT50LF, QT50LS, QT50LR, STG40L, STG40LF, STG50L, STG50LF, STG40L, STG40LF, STG50L, STG50LF</p>
	 <p>QLA24</p>	 <p>ST80B, ST80BF, ST80L, ST80LF, ST80EL, ST80ELF, STC80L, STC80LF, STC80EL, STC80ELF, QT70L, QT70LF, QT70LS, QT70LR</p>

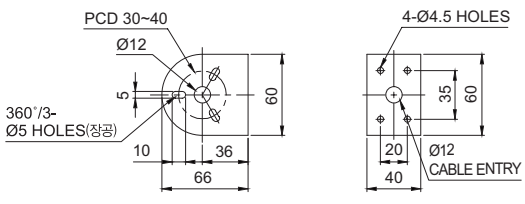

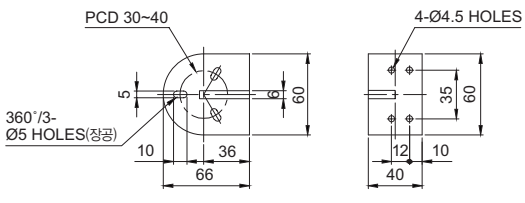

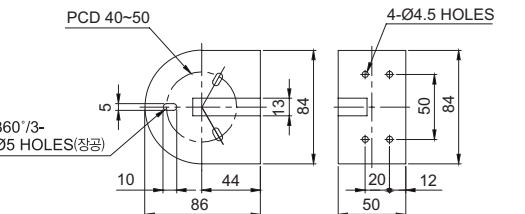
타워램프 취부대

(단위 : mm)

특징	외형	치수 및 적용 제품
<p>표준 직부형 수직 취부대입니다. 벽면과 같은 수직면에 제품을 취부할 때 사용됩니다.</p> <p>재질 : Steel 색상 : Silver, Ivory</p> 	 <p>TWS45</p>	 <p>ST45MB, ST45MBF, ST45ML, ST45MLF, ST56MB, ST56MBF, ST56ML, ST56MLF, ST56MEL, ST56MELF, STG40ML, STG40MLF, STG50ML, STG50MLF, STG50MFL, STC45ML, STC45MLF, STC56ML, STC56MLF, STC56MEL, STC56MELF, QTG50ML, QTG50MLF, QTG60ML, QTG60MLF, QTC50ML, QTC50MLF, QTC60ML, QTC60MLF, QTR50ML, QTR50MLF, QTR60ML, QTR60MLF, QT50ML, QT50MLF, QT50MLS, QT50MLR, QTG60ML-WIZ, QTGMLF-WIZ</p>
<p>제품 전원이 외부로 노출되지 않도록 설계된 고급형 취부대입니다. 벽면과 같은 수직면에 제품을 취부할 때 사용됩니다.</p> <p>재질 : PC 색상 : Black, Ivory</p> 	 <p>TWA45</p>	 <p>ST45MB, ST45MBF, ST45ML, ST45MLF, ST56MB, ST56MBF, ST56ML, ST56MLF, ST56MEL, ST56MELF, STG40ML, STG40MLF, STG50ML, STG50MLF, STG50MFL, STC45ML, STC45MLF, STC56ML, STC56MLF, STC56MEL, STC56MELF, QTG50ML, QTG50MLF, QTG60ML, QTG60MLF, QTC50ML, QTC50MLF, QTC60ML, QTC60MLF, QTR50ML, QTR50MLF, QTR60ML, QTR60MLF, QT50ML, QT50MLF, QT50MLS, QT50MLR, QTG60ML-WIZ, QTG60MLF-WIZ</p>
	 <p>TWA80</p>	 <p>ST80MB, ST80MBF, ST80ML, ST80MLF, STC80ML, STC80MLF, QTG70ML, QTG70MLF, QTC70ML, QTC70MLF, QTR70ML, QTR70MLF, QT70ML, QT70MLF, QT70MLS, QT70MLR, QTG70ML-WIZ, QTG70MLF-WIZ</p>

타워램프 취부대

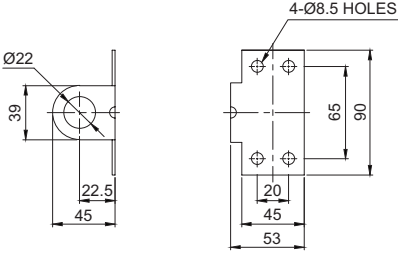
(단위 : mm)

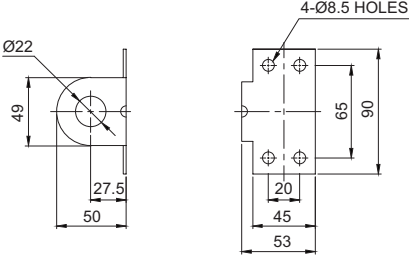
특징	외형	치수 및 적용 제품
<p>슬림형 타워램프 수직 취부대입니다. 벽면과 같은 수직면에 제품을 취부할 때 사용됩니다.</p> <p>재질 : Steel 색상 : Silver, Ivory</p> 	 <p>STAWB25</p>	 <p>STA25SLM, STA35SL, STA35SLM</p>
	 <p>STAWB45</p>	 <p>STA45SLM</p>